

Varenummer: 4320000851  
Beskrivelse: Rota-fix spændelement A 85x125  
Rustfast stål

## Mål

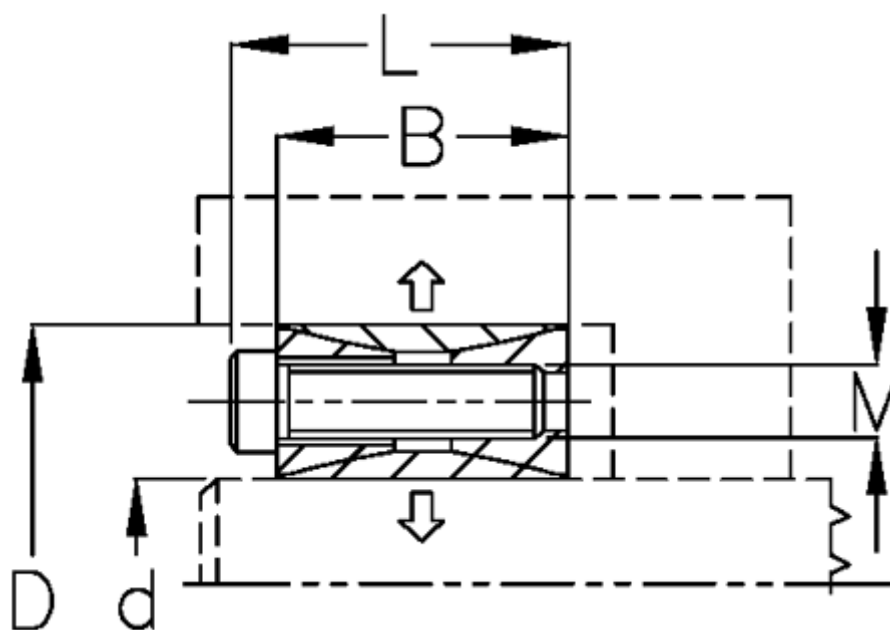

B mm	= 28
d H8 mm	= 85
D mm	= 125
F kN aksialkraft	= 95.2
L mm	= 38
M mm	= M10
Overfladeruhed	= R? ? 3.2 $\mu$ m
P N/mm <sup>2</sup> fladetryk på aksel/nav	= 52

T Nm drejningsmoment	= 4000
Tolerance	= Aksel k11-h11, Nav M
Ts Nm boltetilspændingsmoment	= 44.0